

APMAMPS25MM

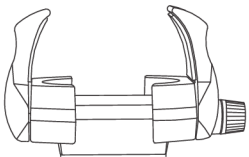

RVKNAMPS

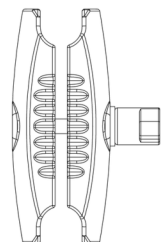

SP-RM250

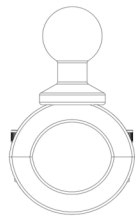

MC25MMB

Includes:

- 1 - RoadVise® Ultra Holder Kit (RVKNAMPS)
- 1 - Metal 4-Hole AMPS to 25mm Ball Adapter (APMAMPS25MM)
- 1 - Robust™ Series 3.75 inch Shaft Arm (SP-RM250)
- 1 - Handlebar Mount with Spacer Rings (MC25MMB)

Compatibility: This holder is suitable for smartphones and tablet with cases measuring up to 5.71" wide.

Please note the RVKNAMPS hardware specifications:

- 4 - M4 x 12mm Screws
- 2 - 3M Adhesive Strips
- 2 - Foam Pads

1 Install the AMPS adapter plate to the device holder

Align the AMPS adapter on the back of the device holder. Then, insert the four mounting screws through the AMPS 4-hole ball adapter plate and into the holder. Finally, secure the screws tightly.

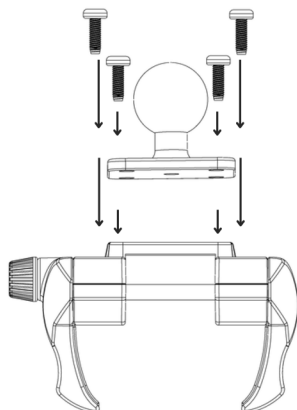

2 Installing the Mount

Position a spacer ring that matches your handlebar around the handlebar. Securely fasten the mount over the spacer ring. Utilize the provided hex key to firmly tighten both mounting screws.

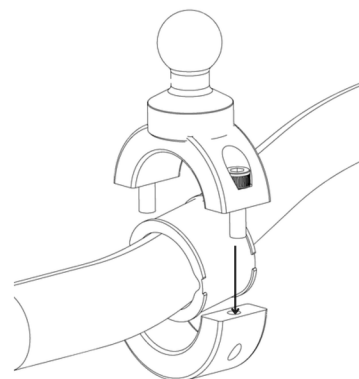

3 Assemble the components

Position the tightening ring over the 25mm ball on the handlebar. Attach the device holder onto the 25mm ball. Finally, tighten the ring to secure the connection.

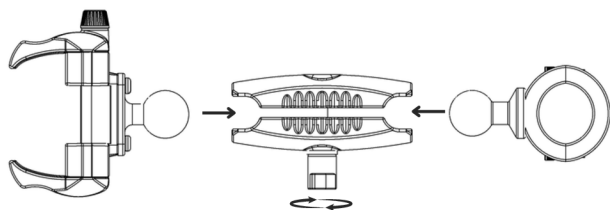

4 Fully Assembled

Refer to the image below for the full assembled product.

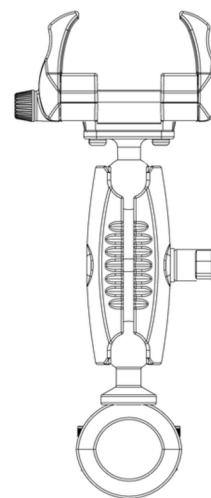

WARNING

CHOKING HAZARD - Keep out of reach from children under 8 yrs. as they can choke or suffocate on parts included with this system

WARNING

Arkon® is not responsible for any damages caused to your device or yourself due to the installation or use of this mount. Do not install Arkon® products near areas that interfere with operation of vehicles. Arkon® assumes no responsibility or liability for injury or death as a result of failure to install in a safe location. Arkon® is not responsible for any damages caused to vehicles, product, or people due to the installation or use of this product.

Continued on page 2

5 Install the foam paddings or adhesive strips

For non-MagSafe chargers, use the included foam paddings for a secure fit in the holder. For MagSafe chargers, apply the adhesive strips on the sides of charger for a secure hold.

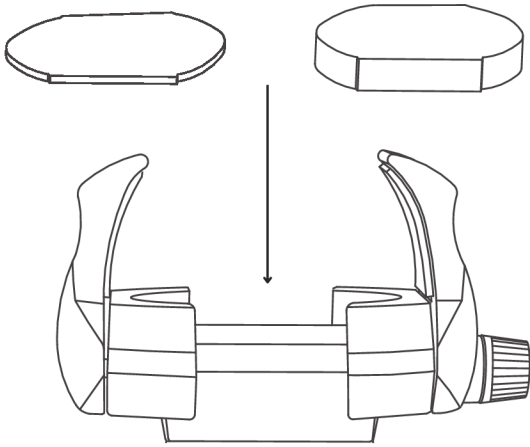

6 Adjust the RoadVise® Ultra holder

To extend the holder for larger devices, turn the center knob on the holder. This will lock the non-spring loaded arm in a secure position to support your device.

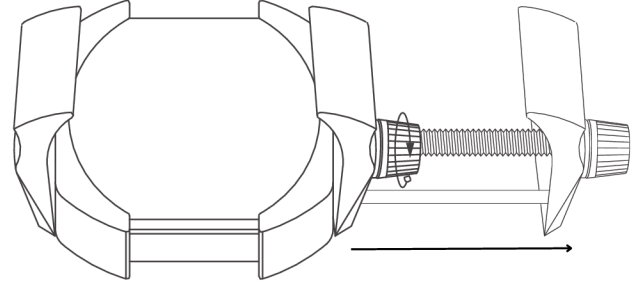

7 Install your device into the phone holder

Expand the spring-loaded arm as you insert your smartphone.

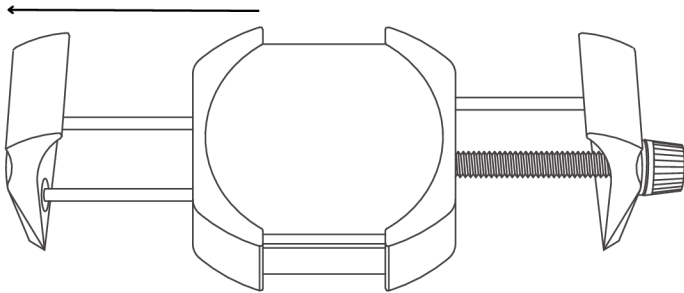

WARNING

CHOKING HAZARD - Keep out of reach from children under 8 yrs. as they can choke or suffocate on parts included with this system

WARNING

Arkon® is not responsible for any damages caused to your device or yourself due to the installation or use of this mount. Do not install Arkon® products near areas that interfere with operation of vehicles. Arkon® assumes no responsibility or liability for injury or death as a result of failure to install in a safe location. Arkon® is not responsible for any damages caused to vehicles, product, or people due to the installation or use of this product.

