

APMAMPS25MM

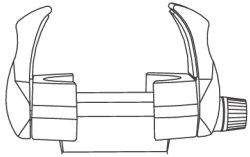

RVKNAMPS

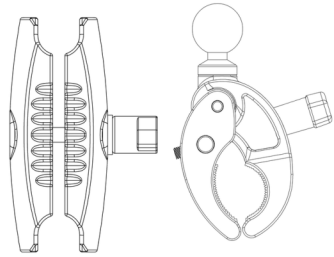

SP-RM250

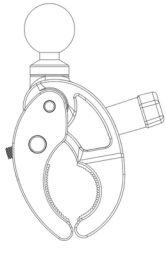

CPMHD

Includes:

- 1 - RoadVise® Ultra Phone and Tablet Holder Kit (RVKNAMPS)
- 1 - Metal 4-Hole AMPS to 25mm Ball Adapter (APMAMPS25MM)
- 1 - Robust™ Series 3.75 inch Shaft Arm (SP-RM250)
- 1 - RoadVise® Clamp Mount with 25mm Ball (CPMHD)

Important: Clean the application surface and make sure it is free of dirt, dust, and grease before installation.

Compatibility: This holder is suitable for smartphones with cases measuring up to 3.5" wide.

Please note the RVKNAMPS hardware specifications:

- 4 - M4 x 12mm Screws
- 2 - 3M Adhesive Strips
- 2 - Foam Pads

- 1 Install the AMPS adapter plate to the device holder**
Align the AMPS adapter on the back of the device holder. Then, insert the four mounting screws through the AMPS 4-hole ball adapter plate and into the holder. Finally, secure the screws tightly.

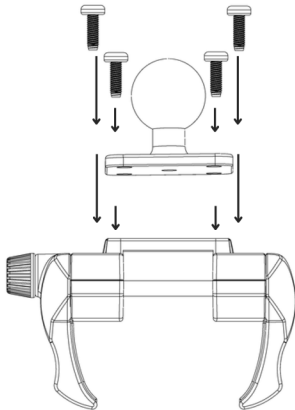

- 2 Assemble the components**
Turn the knob counterclockwise to loosen them. Next, attach the 25mm ball adapters to both ends. Finally, tighten the knob to secure everything in place.

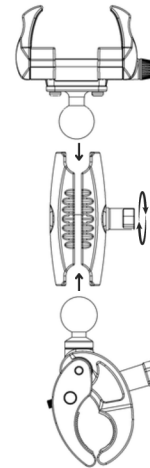

- 3 Adjusting the Clamp Mount**
To widen the clamp arms to the desired width, turn the knob counterclockwise. Attach to your desired surface and then tighten the knob clockwise to secure in place.

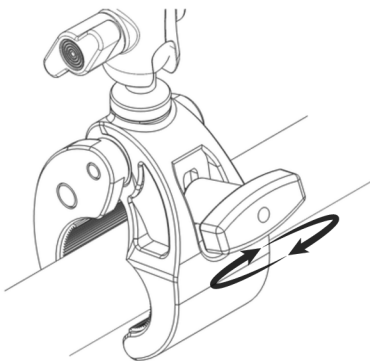

- 4 Fully Assembled**
Refer to the image below for the full assembled product.

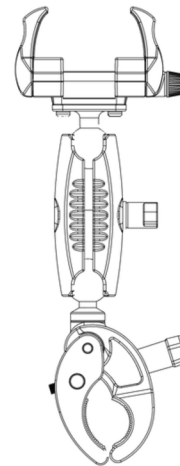

WARNING

CHOKING HAZARD - Keep out of reach from children under 8 yrs. as they can choke or suffocate on parts included with this system

WARNING

Arkon® is not responsible for any damages caused to your device or yourself due to the installation or use of this mount. Do not install Arkon® products near areas that interfere with operation of vehicles. Arkon® assumes no responsibility or liability for injury or death as a result of failure to install in a safe location. Arkon® is not responsible for any damages caused to vehicles, product, or people due to the installation or use of this product.

Continued on page 2

5 Install the foam paddings or adhesive strips

For non-MagSafe chargers, use the included foam paddings for a secure fit in the holder. For MagSafe chargers, apply the adhesive strips on the sides of charger for a secure hold.

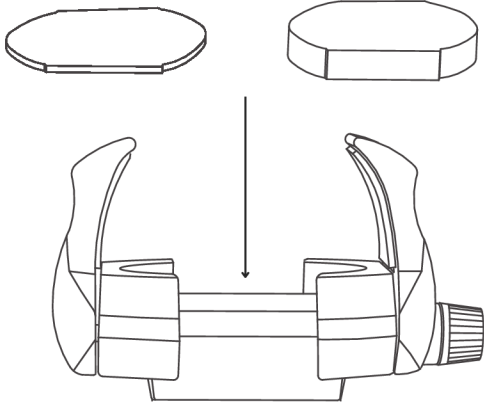

6 Adjust the RoadVise® Ultra holder

To extend the holder for larger devices, turn the center knob on the holder. This will lock the non-spring loaded arm in a secure position to support your device.

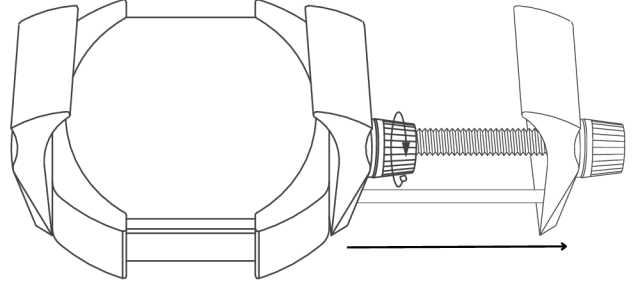

7 Install your device into the phone holder

Expand the spring-loaded arm as you insert your smartphone.

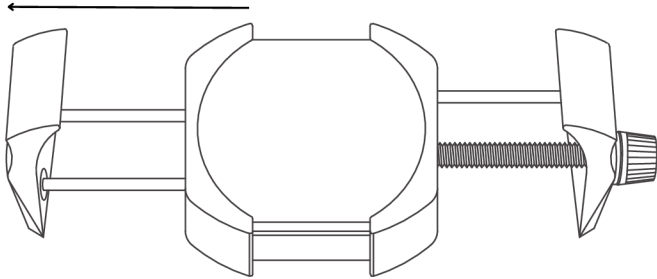

WARNING

CHOKING HAZARD - Keep out of reach from children under 8 yrs. as they can choke or suffocate on parts included with this system

WARNING

Arkon® is not responsible for any damages caused to your device or yourself due to the installation or use of this mount. Do not install Arkon® products near areas that interfere with operation of vehicles. Arkon® assumes no responsibility or liability for injury or death as a result of failure to install in a safe location. Arkon® is not responsible for any damages caused to vehicles, product, or people due to the installation or use of this product.

